

Installation manual for trimmed to size pleated blind VS2

1

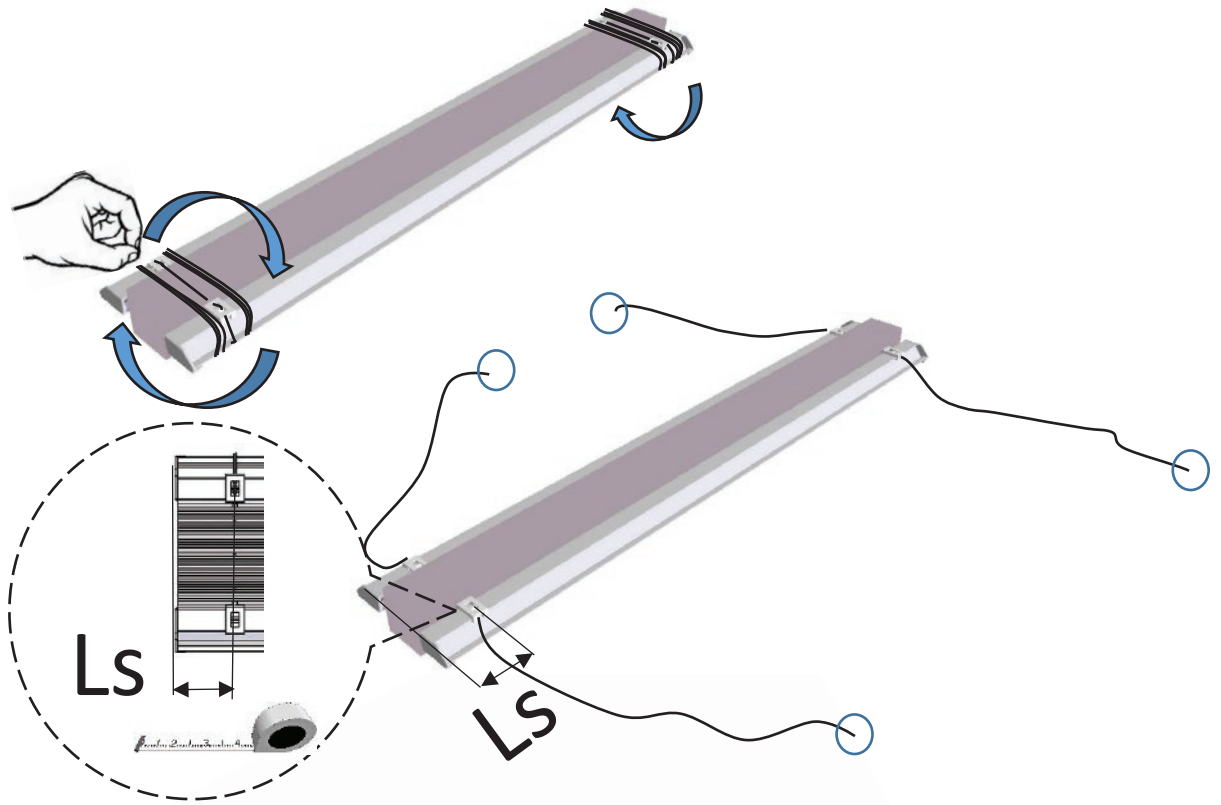

2

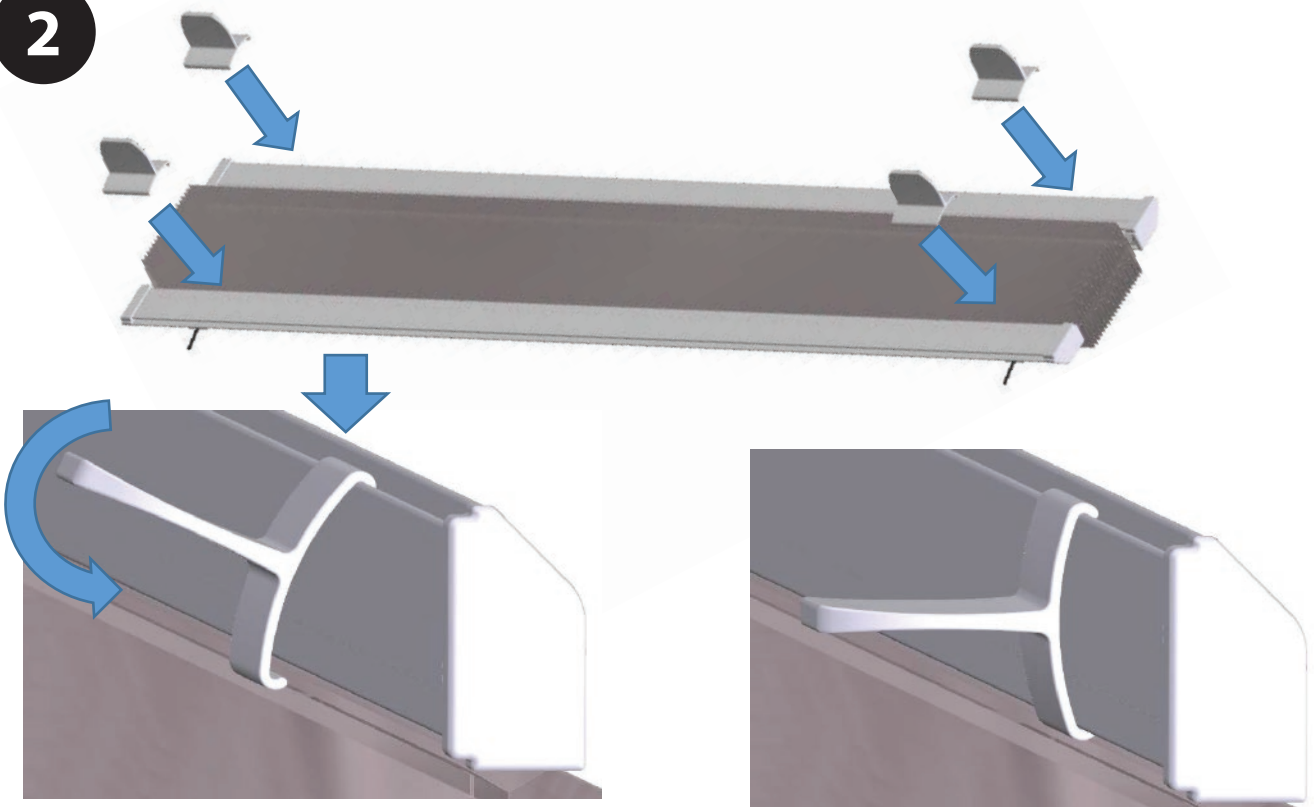

v1 MOUNTING TO THE GLAZING BEAD

3 ^{v1}

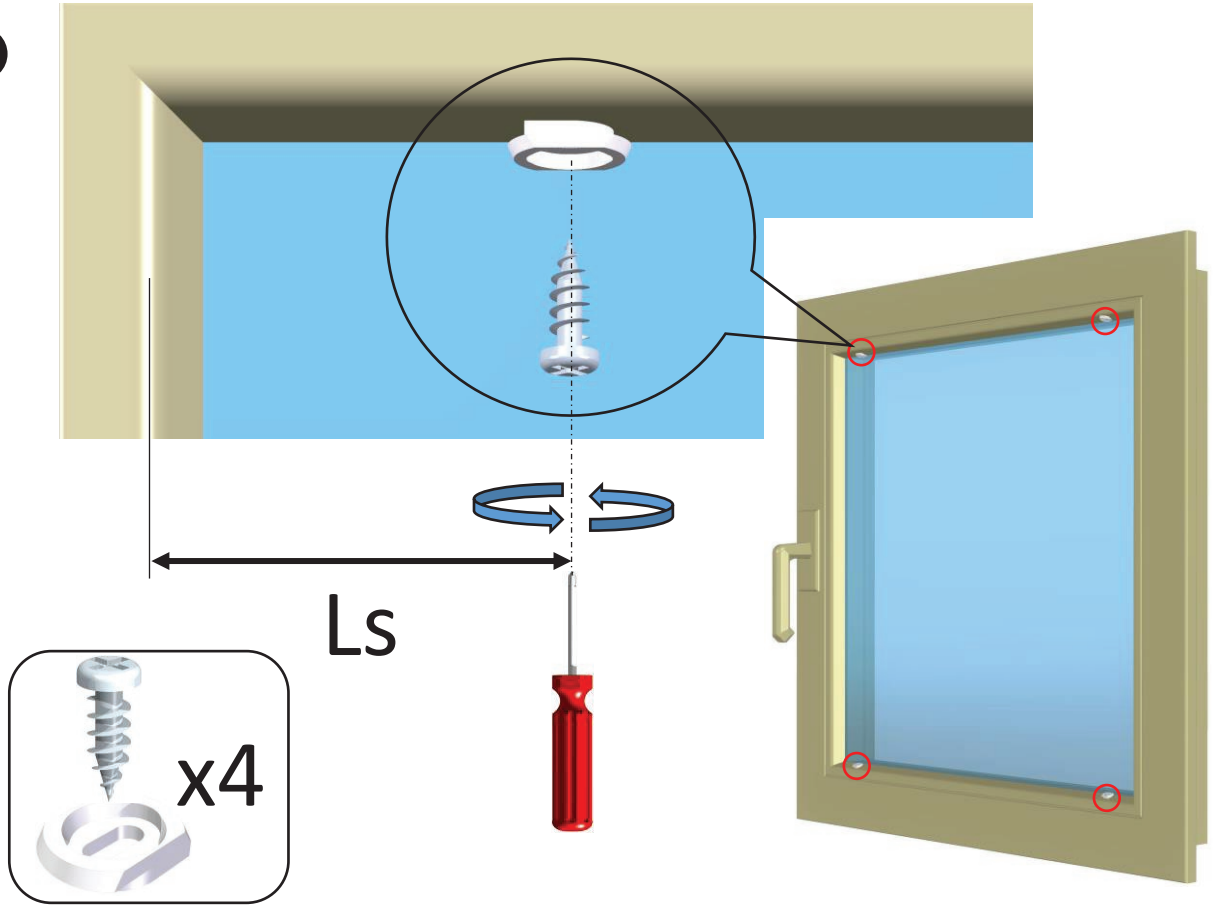

4 ^{v1}

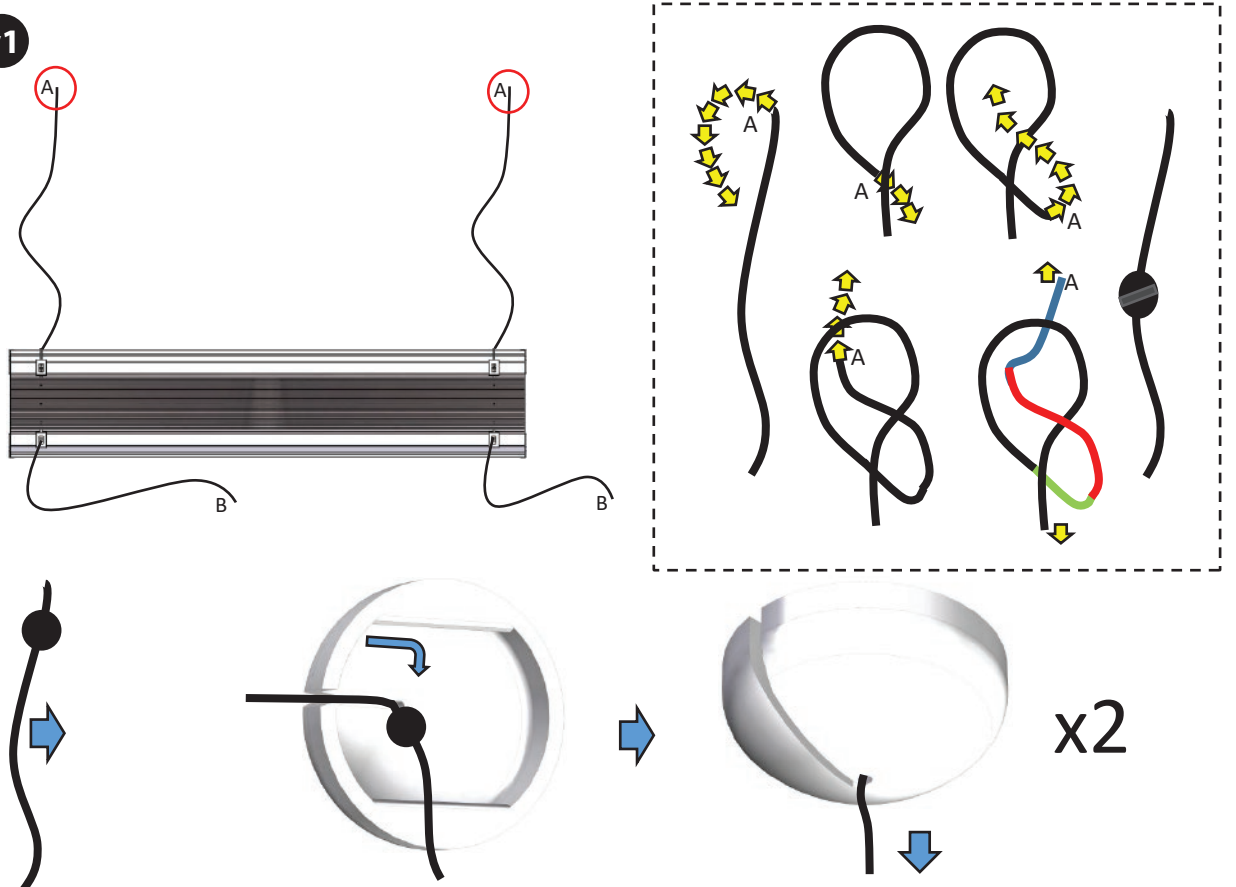

5 ^{v1}

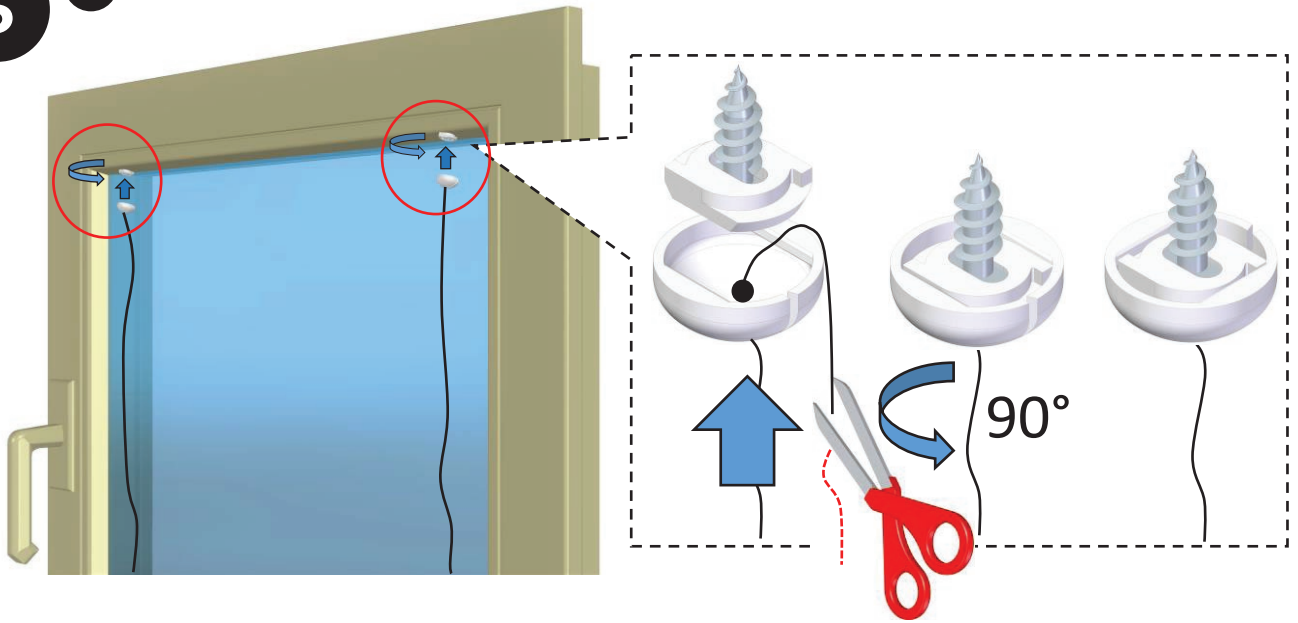

6 ^{v1}

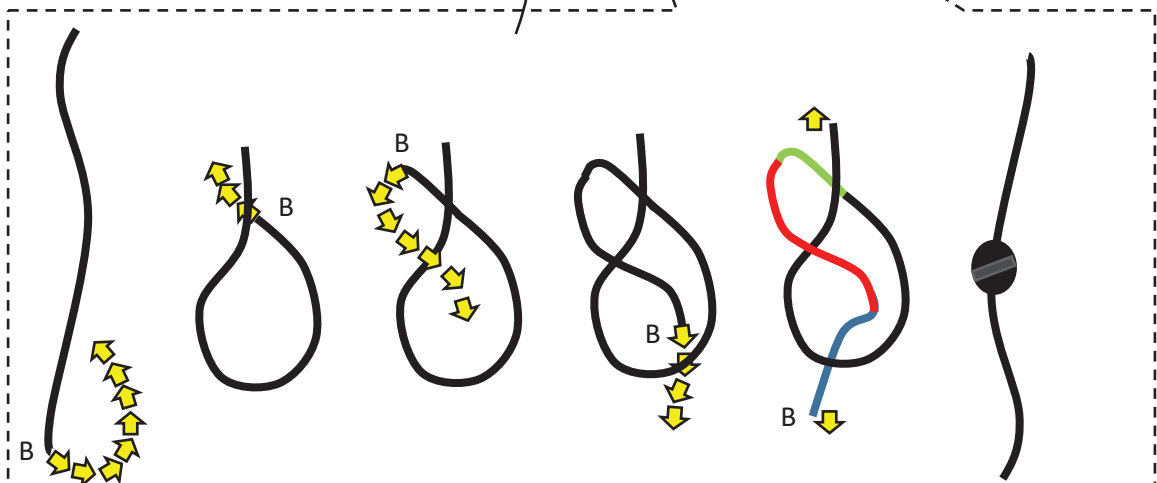
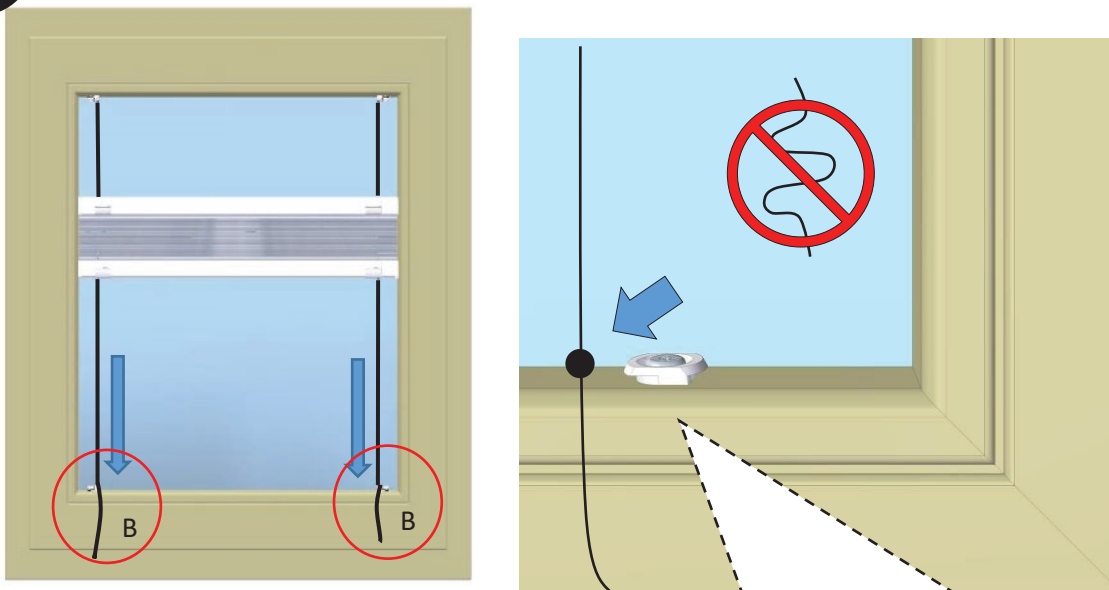

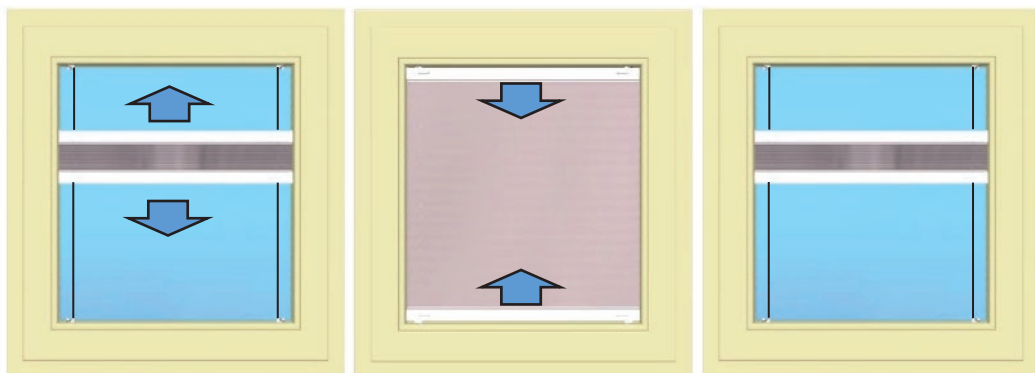
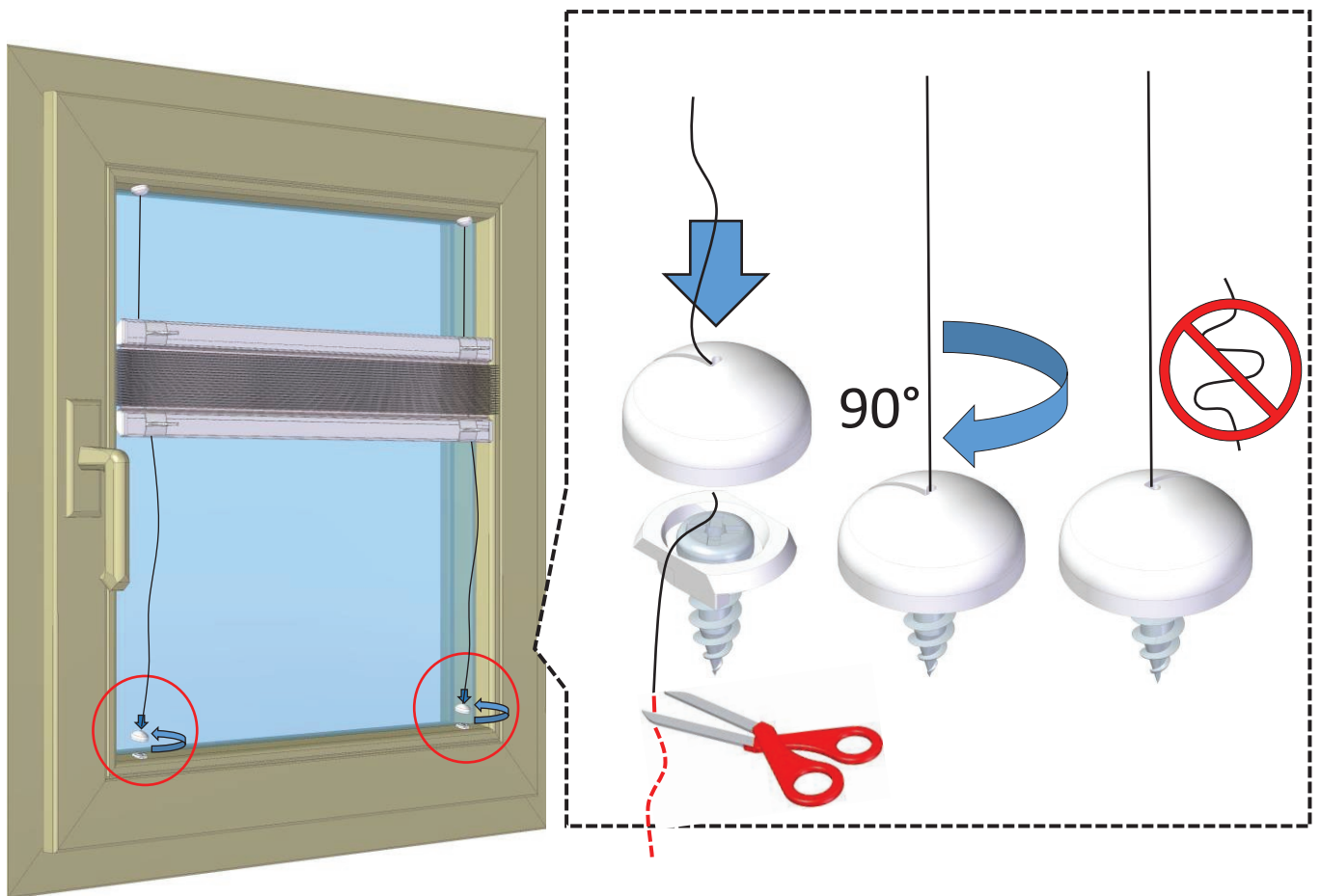
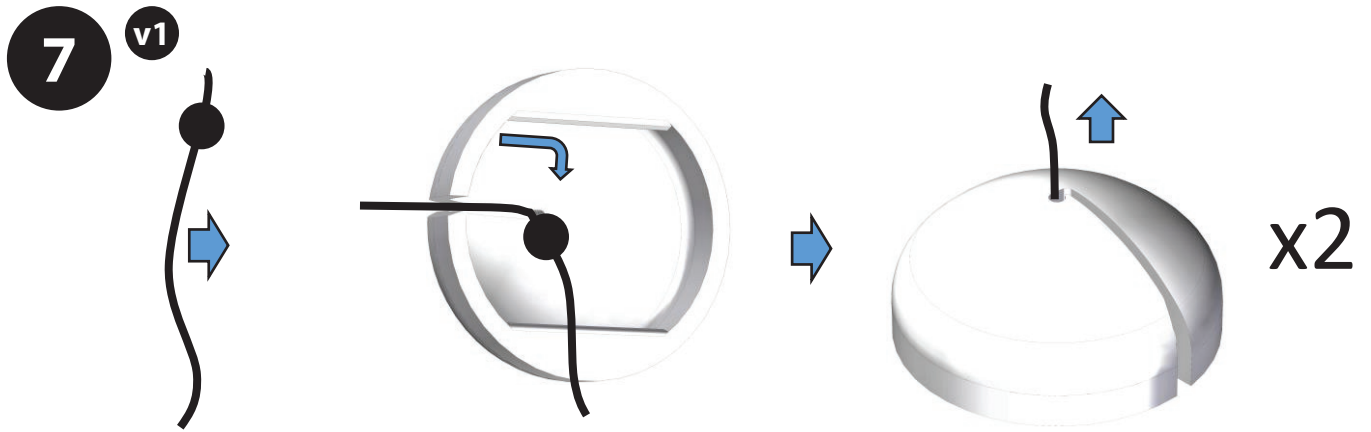

v2 MOUNTING ON A WINDOW FRAME

3 v2

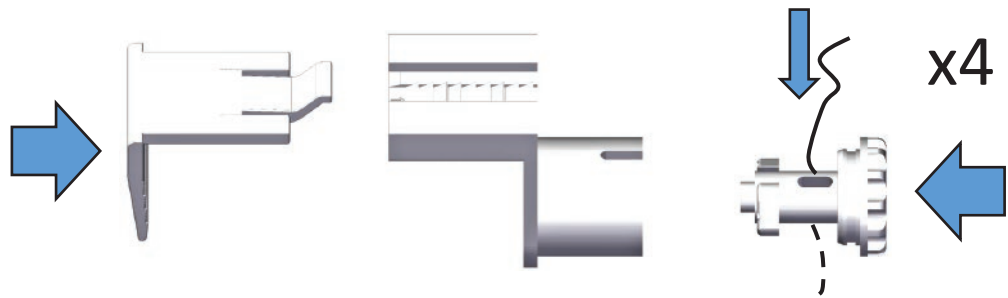

4 v2

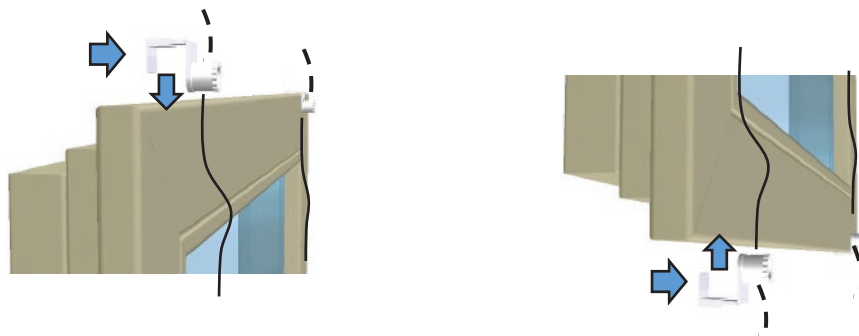

5 v2

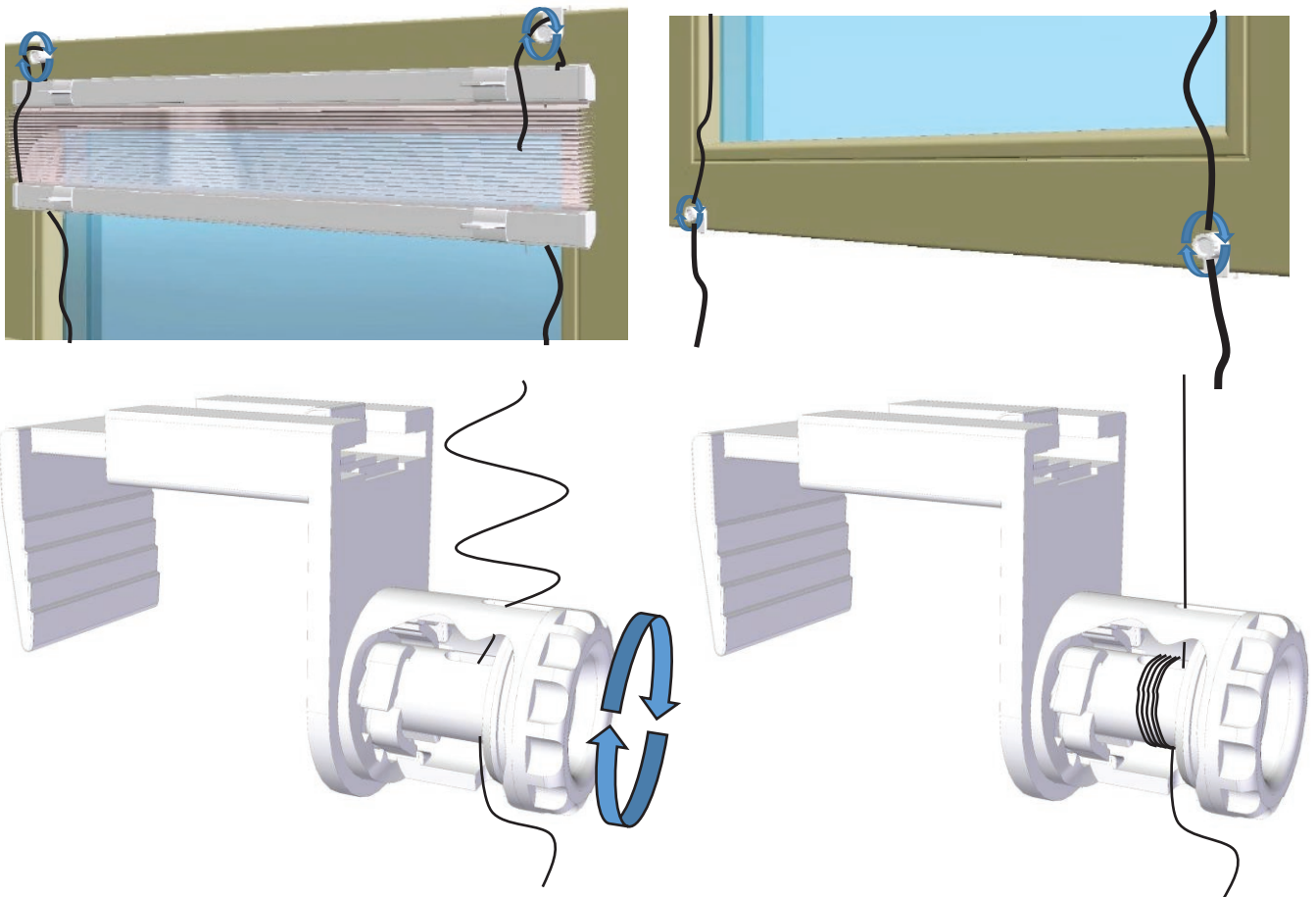

6 v2

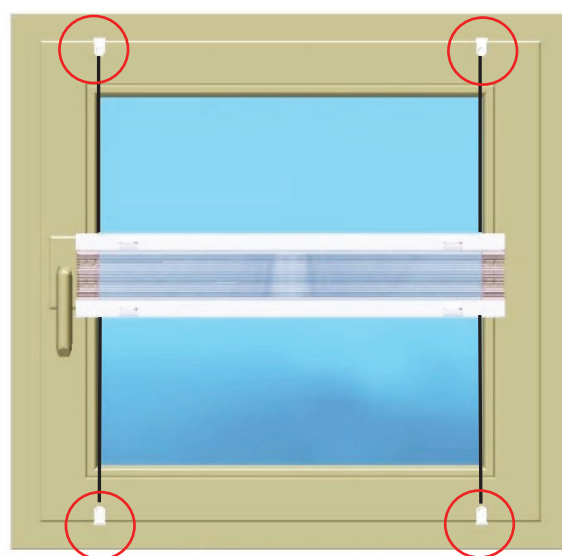
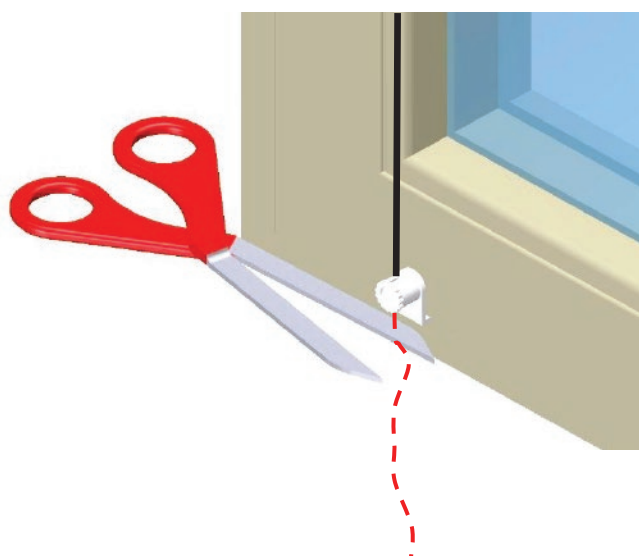
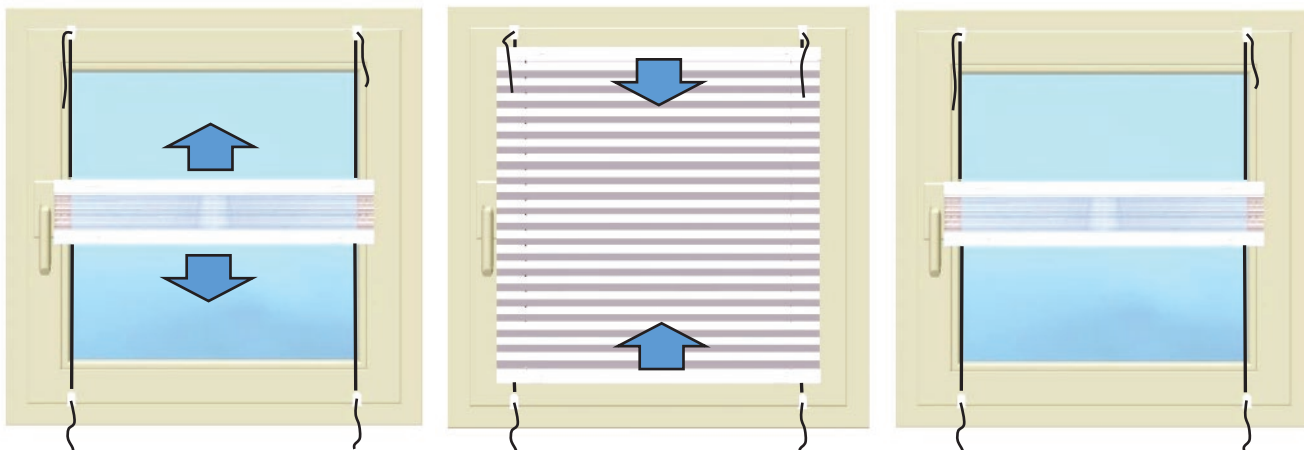

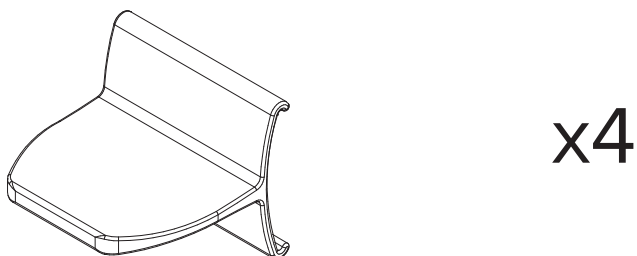
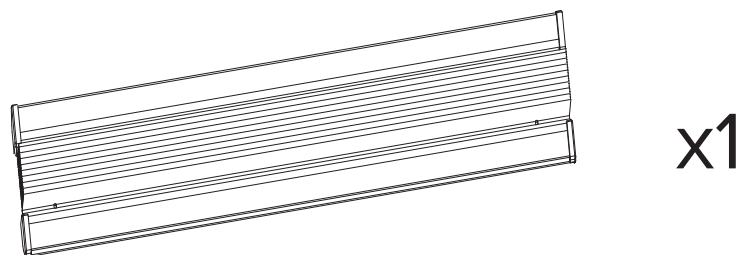

v1

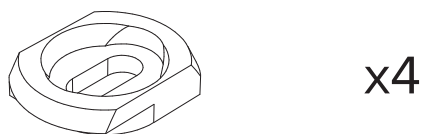
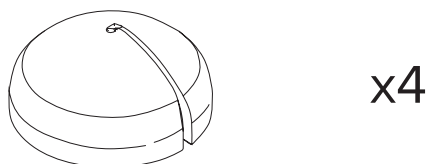

v2

